

Standard Monitor Range

Hand Monitors

HM80
LMB48
LMB40

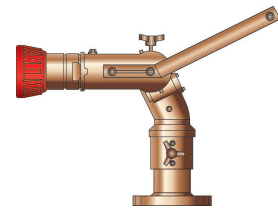

Geared Monitors

GMB48
GMB50
GMB75
GMB85
GMS45
FWM

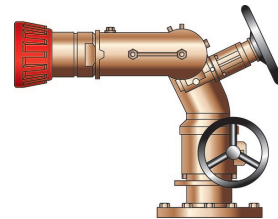

Oscillating Monitors

OM80
OMB40

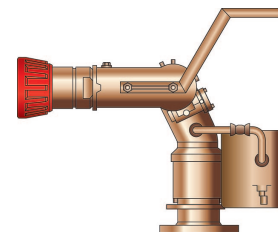

Portable Monitors

Bipod Foam Monitors
Titan Bipod
PGM1



Standard Monitor Range

Hand Monitors

HM80

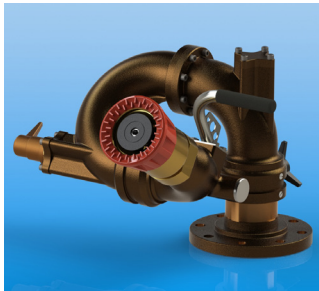

Specification

Operating pressure: Max: 16 bar g,
Min: 5 bar g
Test pressure: 24 bar g
Maximum flow: 4,500 litres/min
Inlet flange connection: 4" ANSI Class 150 RF
Outlet connections: 2", 2½" BSP Male or flanged for LTC Cannons
Rotation: 360° continuous
Elevation (nominal): 75°-75° from horizontal
Approx. weight (without nozzle/cannon): 32 kg

Standard Nozzles

LTN Long Throw Nozzles with flow rates: 900 - 3300 lpm

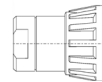

Self Inducing Long Throw Nozzle with flow rate: 1900 lpm

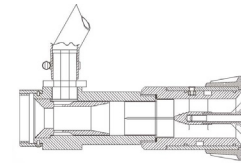

Standard Cannons

To be used with counterbalance only
Long Throw Cannons with flow rates: 1800 - 3300 lpm

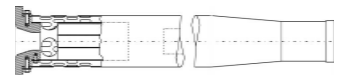

LTC/B Self-Inducing option

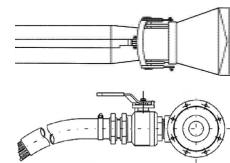

LMB48

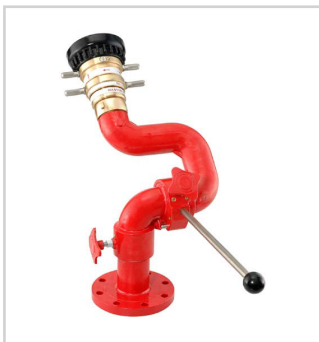

Specification

Operating pressure: Max: 14 bar g,
Min: 5 bar g
Test pressure: 34 bar g
Maximum flow: 4,800 litres/min
Inlet flange connection: 3" or 4" ANSI Class 150
Outlet connections: 2½" BSP Male
Rotation: 360° continuous
Elevation (nominal): +90°-60° from horizontal
Approx. weight (without nozzle): 25 kg

Standard Nozzles

FJ19-48 Fog Jet Nozzle with selectable flow rate: 1900 - 2900 - 3900 - 4800 lpm

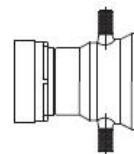

FJS13-29 Self Inducing Fog Jet Nozzles with factory set flow: 1325 - 1900 - 2900 lpm
FJS3800 Self Inducing Fog Jet Nozzle with flow rate: 3800 lpm

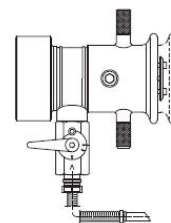

LMB40



Specification

Operating pressure: Max: 16 bar g,
Min: 5 bar g
Test pressure: 24 bar g
Maximum flow: 4,000 litres/min
Inlet flange connection: 4" ANSI Class 150
Outlet connections: 2½" BSP Female
Rotation: 360° continuous
Elevation (nominal): +85°-50° from horizontal
Approx. weight (without nozzle/cannon): 57 kg

Standard Nozzles

FJ1300 - FJ4000 Fog Jet Nozzles with flow rates: 1300-4000 lpm

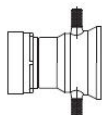

FJS1300 - FJS4000 Self Inducing Fog Jet Nozzles

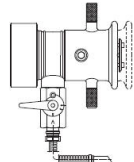

Standard Cannons

To be used with counterbalance only
FC1300-FC4000 Foam Cannons with flow rates: 1300 - 4000 lpm

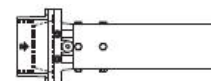

FCS1300 - FCS4000 Self Inducing Cannons

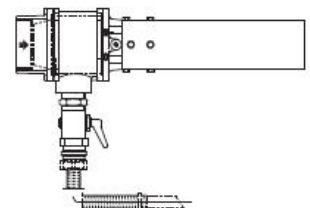

Geared Monitors

GMB48



Specification

Operating pressure: Max: 14 bar g,
Min: 5 bar g
Test pressure: 34 bar g
Maximum flow: 4,800 litres/min
Inlet flange connection: 3" or 4" ANSI
Class 150
Outlet connections: 2½" BSP Male
Rotation: 360° continuous
Elevation (nominal): +85°-55° from
horizontal
Approx. weight (without nozzle):
26 kg

Standard Nozzles

FJ19-48 Fog Jet Nozzle with
selectable flow rate:
1900 - 2900 - 3800 - 4800 lpm

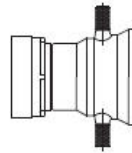

FJS13-29 Self Inducing Fog Jet
Nozzles with factory set flow:
1325 - 1900 - 2900 lpm
FJS3800 Self Inducing Fog Jet
Nozzle with flow rate: 3800 lpm

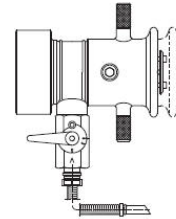

GMB50

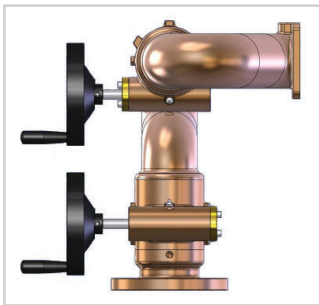

Specification

Operating pressure: Max: 16 bar g,
Min: 5 bar g
Test pressure: 24 bar g
Maximum flow: 5,000 litres/min
Inlet flange connection: 4" ANSI Class
150 FF
Outlet connections: 150 x 150 square
flange
Rotation: 360° continuous
Elevation (nominal): +85°-50° from
horizontal
Approx. weight (without nozzle/
cannon): 62 kg

Standard Nozzles

FJ1300 - FJ5000 Fog Jet Nozzles
with flow rates: 1300-5000 lpm

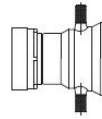

FJS1300 - FJS5000 Self Inducing
Fog Jet Nozzles

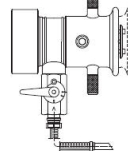

Standard Cannons

FC1300-FC5000 Foam Cannons
with flow rates: 1300 - 5000 lpm

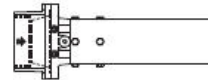

FCS1300 - FCS5000 Self Inducing Cannons

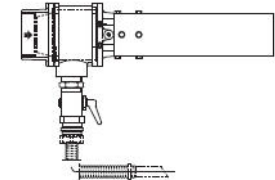

GMB75



Specification

Operating pressure: Max: 14 bar g,
Min: 5 bar g
Test pressure: 34 bar g
Maximum flow: 7570 litres/min
Inlet flange connection: 4" or 6" ANSI
Class 150
Outlet connections: 3½" BSP Male
Rotation: 360° continuous
Elevation (nominal): +90°-45° from
horizontal
Approx. weight (without nozzle/
cannon): 50 kg

Standard Nozzles

FJ7570 Fog Jet Nozzle
with flow rate: 7570 lpm

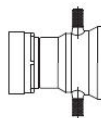

Geared Monitors

GMB85



Specification

Operating pressure: Max: 16 bar g,
Min: 5 bar g
Test pressure: 24 bar g
Maximum flow: 8500 litres/min
Inlet flange connection: 6" ANSI
Class 150
Outlet connections: 150 x 150 square
flange
Rotation: 360° continuous
Elevation (nominal): +85°-55° from
horizontal
Approx. weight (without nozzle):
76 kg

Standard Nozzles

FJ5000 - FJ8500 Fog Jet
Nozzles with flow rates
5000 - 8500lpm

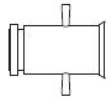

FJS4000 Self Inducing Nozzle

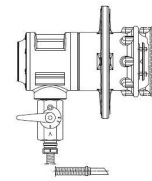

Standard Cannons

FCL5000 - FCL6500 Lightweight
Foam Cannons with flow rates:
5000-6500lpm



FCLS5000 - FCLS8500 Self Inducing
Lightweight Foam Cannons

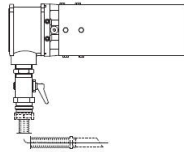

GMS45 (Stainless Steel)



Specification

Operating pressure: Max: 12 bar g
Test pressure: 25 bar g
Maximum flow: 4,500 litres/min
Inlet flange connection: 4" ANSI
Class 150 FF
Outlet connections: 4" BSP Male
Rotation: 360° continuous
Elevation (nominal): +90°-65° from
horizontal
Approx. weight (without nozzle/
cannon): 62 kg

Standard Nozzles

H50 SS Fog Jet Nozzle with
factory set flow rate:
3030 - 4750 lpm

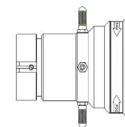

HSI 50 SS Self Inducing Fog Jet
Nozzle with factory set flow
rate: 3030 - 4750 lpm

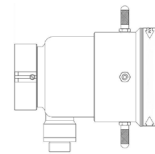

FOAM WATER MONITORS

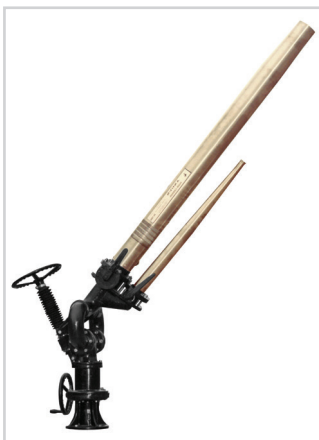

Specification

Operating pressure : Max: 10 bar g,
Min: 5 bar g
Flow at 7 bar: FWM1300 - 1300 lpm
FWM1800 - 1800 lpm
FWM2700 - 2700 lpm
FWM3600 - 3600 lpm
Rotation: 360° continuous
Elevation (nominal): +70°-20° from
horizontal
Inlet connection: 4" ANSI Class 150 RF
Foam Induction: Variable between
3 - 6%
Approx. weight : FWM1300 - 91 kg
FWM1800 - 90 kg
FWM2700 - 90 kg
FWM3600 - 111 kg

Fixed Oscillating Monitors

OM80



Specification

Operating pressure: Max: 16 bar g,
Min: 5 bar g

Test pressure: 24 bar g

Maximum flow: 4,500 litres/min

Inlet flange connection: 4" ANSI
Class 150

Outlet connections: 2½" BSP Male

Sweep angle:
Automatic: 45° to 120° in 15° intervals
Manual: 360° continuous

Nominal elevation*: Max +75° above
horizontal (+85° in upright mode)

Nominal depression*:
Max -70° below horizontal.
Limited to -5° over gearbox in low
profile mode.
Limited to -45° or -20° over gearbox
in upright mode

Nominal oscillating frequency:
8 cycles/min @ 7 bar g

Approx. weight (without nozzle/
cannon): 77 kg

** Low profile to upright mode
adjustable on site (see O&M manual)*

Standard Nozzles

LTN Long Throw Nozzles with
flow rates: 900 - 3300 lpm

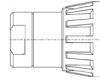

Self Inducing Long Throw Nozzle
with flow rate: 1900 lpm

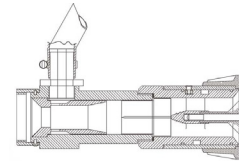

Standard Cannons

To be used with counterbalance only
Long Throw Cannons with flow rates:
1800 - 3300 lpm

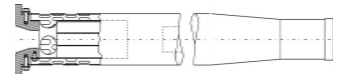

LTC/B Self-Inducing option

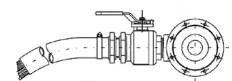
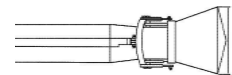

OMB40



Specification

Operating pressure: Max: 16 bar g,
Min: 5 bar g

Test pressure: 24 bar g

Maximum flow: 4,000 litres/min

Inlet flange connection: 4" ANSI
Class 150 FF

Outlet connections: 2½" BSP Female

Sweep angle:
Automatic: 30° to 120° in 15° intervals
Manual: 360° continuous

Nominal elevation:
Max +85° above horizontal

Nominal depression:
Max -45° below horizontal.

Nominal oscillating frequency:
5°/sec at 7 bar inlet pressure

Approx. weight (without nozzle/
cannon): 40 kg

Standard Nozzles

FJ1300 - FJ4000 Fog Jet Nozzles
with flow rates: 1300-4000lpm

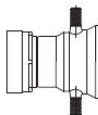

FJS1300 - FJS4000 Self Inducing
Fog Jet Nozzles

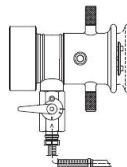

Standard Cannons

To be used with counterbalance only
FC1300-FC4000 Foam Cannons
with flow rates: 1300 - 4000 lpm

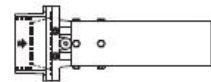

FCS1300 - FCS4000 Self Inducing Cannons

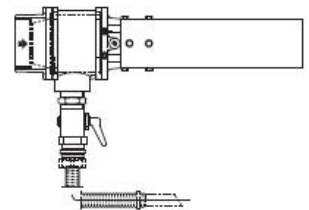

Portable Monitors

BIPOD FOAM MONITORS



Specification

Operating pressure: Max: 12 bar g,
Min: 5 bar g

Flow at 7 bar: FC18B - 1800 lpm
FC27B - 2700 lpm

Inlet connection:
4 x 2½" Instantaneous Male

Foam Induction:
Variable between 1% - 7%

Foam Expansion Ratio: Typically 6:1

Approx. weight: FC18B - 40 kg
FC27B - 42 kg

TITAN BIPOD



Specification

Operating pressure: Max: 12 bar g,
Min: 5 bar g

Flow at 7 bar: 3700 lpm

Inlet connection: 2 x 4" Storz

Foam Induction: Fixed at 3% or 6%

Foam Expansion Ratio: Typically 5:1

Approx. weight: 41 kg

PGM1



Specification

Operating pressure: Max: 10 bar g,
Min: 4 bar g

Test pressure: 15 bar g

Maximum flow at 7 bar: 1800 lpm
when used with N1800 nozzle

Inlet connection:
2 x 2½" Instantaneous Male

Approx. weight (without nozzle): 7 kg

The PGM1 is intended for use in the medium output range, typically up to 400 gpm (1800 lpm) but higher outputs can be tolerated by using the anchor spike which is also recommended for use on smooth surfaces to assist in resisting jet reaction forces

Standard Nozzles

N Range Jet Spray Nozzle
with flow rates: 900 or 1800 lpm



INTERNATIONAL SALES

Angus Fire Ltd

Angus House, Haddenham Business Park,
Pegasus Way, Haddenham, Aylesbury, HP17 8LB, UK
Tel: +44 (0)1844 293600 • Fax: +44 (0)1844 293664

UK SALES

Angus Fire Ltd

Station Road, Bentham, Lancaster, LA2 7NA, UK
Tel: +44 (0)1524 264000 • Fax: +44 (0)1524 264180

Angus Fire operates a continuous programme of product development. The right is therefore reserved to modify any specification without prior notice and Angus Fire should be contacted to ensure that the current issues of all technical data sheets are used.

© Angus Fire
6866/1 08.17